

DANTHERM

COOLING

ThermoFlow®

High Efficiency Thermosiphon Heat Exchange Technology



DANTHERM
COOLING

DANTHERMCOOLING.COM

TECHSUPPORT@DANTHERMCOOLING.COM | 864-595-9800

671 SPRINGFIELD ROAD | SPARTANBURG, SOUTH CAROLINA 29303



About Dantherm Cooling

Performance Cooling

Over the past 28 years, Dantherm cooling has established itself as a leader in innovative cooling systems, applying more than 300,000 climate control units to mission critical applications. By applying our passion for performance and quality throughout our company, we have become known for providing outstanding products and an exceptional customer experience.

Our innovative, highly engineered product lines feature industry leading technology to deliver outstanding performance, operate efficiently and perform reliably in extreme climate conditions. Backed by our experienced design team, quality manufacturing processes and extensive testing and certification practices, Dantherm Cooling can provide customers with engineered solutions to their most challenging applications.

Our passion and success in building an industry leading business compels us to invest in those around us. From our servant leader approach to our employees, to regular community outreach, we are compelled to use our business a catalyst for positivity in the lives of those around us.



ThermoFlow[®]

Dantherm Cooling's ThermoFlow heat exchange technology delivers a compact solution with greater passive cooling capacity than standard air-to-air heat exchangers.

Featuring our patent pending thermosiphon technology, the Dantherm ThermoFlow system uses a working fluid-based heat exchange without a compressor and the only moving components are two energy-efficient fans and the natural convection flow of the working fluid within the internal coil. As the internal coil absorbs the heat inside the cabinet or enclosure, the working fluid begins to circulate. This convective movement causes the fluid to undergo a phase-shift and evaporate into gas. The ThermoFlow unit utilizes this phase-shifting energy to generate passive heat exchange which cools down the inside of the cabinet or enclosure – an elegant, and economical, energy-saving, closed-loop cooling solution.

The optimal performance delivered through our innovative design creates notable energy savings and low operating cost while delivering powerful cooling performance.

ThermoFlow®

*Energy Efficient Cooling For Electrical Gear,
Electronics, and Mechanical Equipment Enclosures*

Utilizing innovative design and technology to produce performance cooling has been part of our history dating back to 1958. Our ThermoFlow systems utilize our extensive engineering and manufacturing expertise to deliver an energy-efficient and powerful cooling solution.

All of our products are manufactured to tight tolerances and thoroughly tested before they leave our factory. With over 300,000 units operating in mission critical applications, customers can be assured of long life and industry leading performance.

- Energy savings delivers high return on initial investment and low dollar to watt ratio
- Features patent pending Dantherm thermosiphon technology
- Engineered for high-energy efficiency and maximum thermal transfer capacity
- Closed-loop cooling prevents ingress of contaminants
- Compact, lightweight units with easy installation
- Fan speed controller with alarm output allow performance tuning to specific application

Engineered Performance

Designed to Meet Demanding Customer Requirements

Innovative Design

Patent-pending thermosiphon technology increases efficient passive cooling process and lowers operating costs

Powerful Cooling

High-performance, high-static pressure fans delivers improved passive cooling capacity

Energy Savings

Innovative design and high quality performance components deliver high energy efficiency

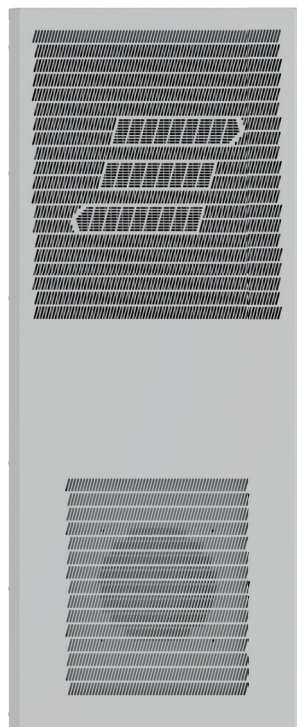

Reliable

Closed loop design and weatherproof enclosure for most challenging environments

Tuned Performance

Adjust fan speeds and tune performance for each installation

Low Maintenance

Lightweight and easy to install with minimal maintenance requirements

ThermoFlow®

Verified Performance, Quality Assured

Dantherm Cooling's commitment to high-quality innovation, manufacturing and customer support is demonstrated by the standards we keep.

Our products are routinely used in critical infrastructure applications and our customers require the highest performance, quality and reliability. Third party certification and verification gives customers a sense of security knowing that our products have been independently tested to perform to the caliber we claim.



Dantherm Cooling's ISO 9001:2015 certification demonstrates that our business and manufacturing processes meet all international standards for the consistent delivery of high-quality products and services. Regular audits and process reviews ensure consistent manufacturing performance.



Through our partnership with Underwriter's Laboratory (UL), UL has certified that all Dantherm Cooling materials and products, as well as specific testing procedures and documentation, have been thoroughly inspected for safety and quality, and meet or exceed established standard requirements.



ThermoFlow®

Technical Specifications

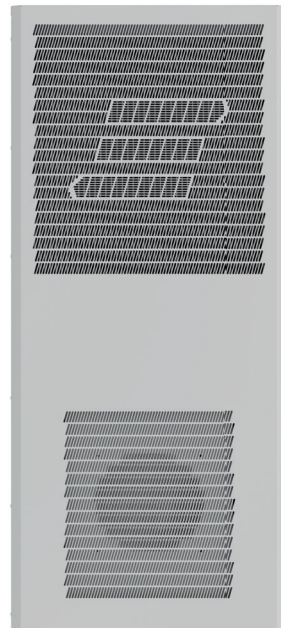

ThermoFlow®

Configure Your ThermoFlow

ThermoFlow systems are easily configurable for a wide number of applications and customer requirements.

All of our products are manufactured to tight tolerances and thoroughly tested before they leave our factory. With over 250,000 units installed in the field in a variety of industries Dantherm products are proven performers.

TF-120-48-03

CAPACITY

120 - 120 WATTS/°F
175 - 175 WATTS/°F
230 - 230 WATTS/°F

VOLTAGE

48 - 48 VDC

COLOR

03 - P03 GREY
04 - P04 BEIGE
20 - P20 WHITE
00 - CUSTOM

Color Options

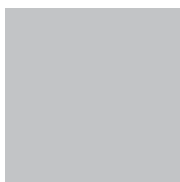

03 - P03 Grey



04 - P04 Beige

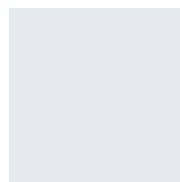

20 - P20 White



00 - Custom

ThermoFlow®

Capacity & Dimensional Drawings

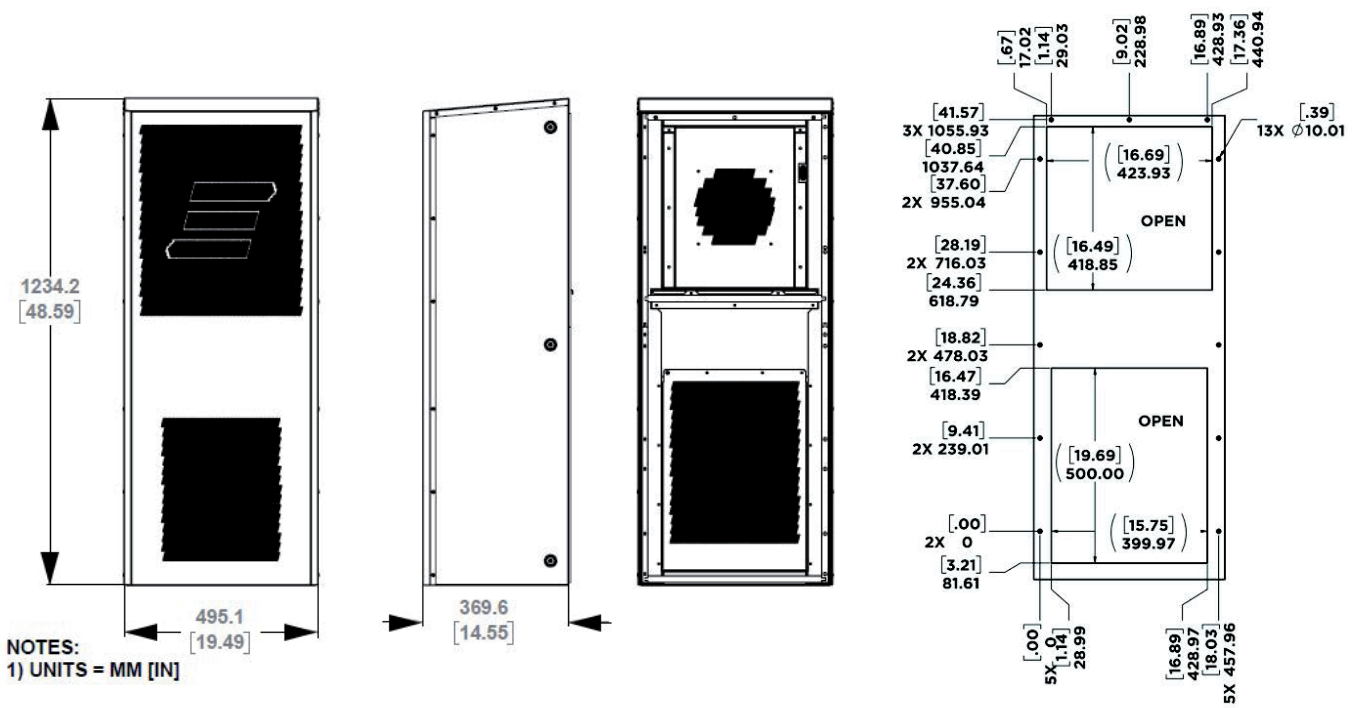
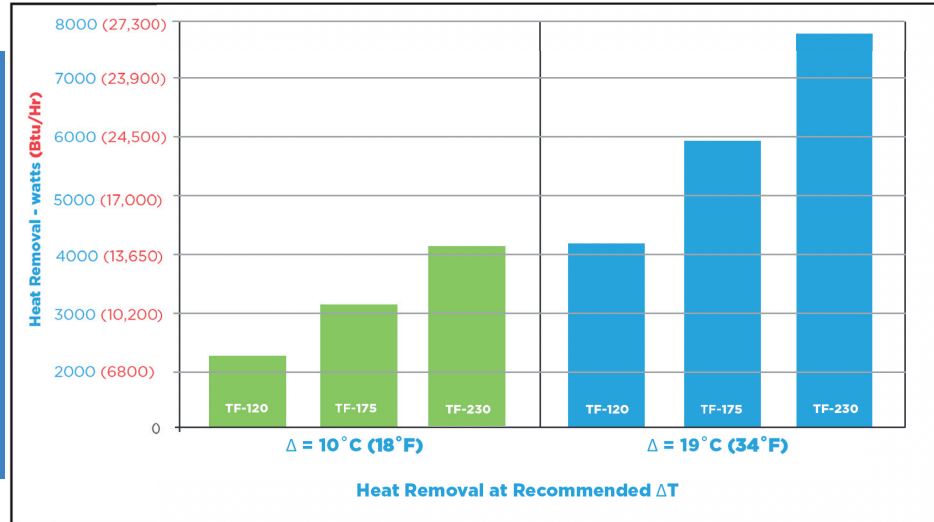
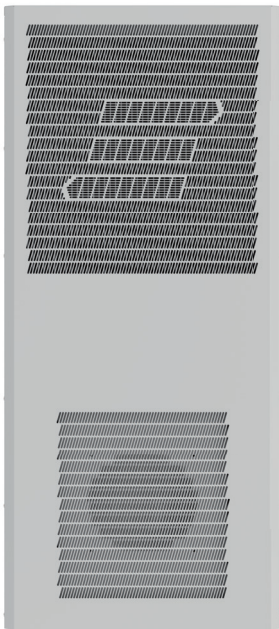

ThermoFlow®

Technical Data

	UNITS			
MODEL NUMBER		TF-120-48	TF-175-48	TF-230-48
MOUNTING METHOD		Outdoor		
UNIT DIMENSIONS [HxWxD]	Inches	48.5x19.5x14.4		
WEIGHT	Lbs	90		
COOLING CAPACITY 131°F INTERNAL / 131°F AMBIENT	W/°F [W/°C]	120 [216]	150 [315]	230 [414]
OPERATIONAL TEMPERATURE RANGE	°F	-40 to 131		
AIRFLOW - MAXIMUM	CFM [m ³ /hr]	710 [1203]	1150 [1950]	1375 [2350]
NOISE 1.5M DISTANCE	dB(A)	63		
INPUT VOLTAGE /FREQUENCY	Volts	48 VDC		
CURRENT	Amps	5.6	4.8	8.2
APPROVALS		SA10718 (UL)		
NEMA		3R		
CONSTRUCTION		Aluzink Steel, Stainless Optional Textured Powder Coat, Color Options Available		

DANTHERM
COOLING

DANTHERMCOOLING.COM

TECHSUPPORT@DANTHERMCOOLING.COM 864-595-9800

671 SPRINGFIELD ROAD SPARTANBURG, SOUTH CAROLINA 29303